

**Vaciador automático para lavabo y bidé**Acabado: **Cromo** ref.: **94139000****Descripción****Características**

- Para lavabos con rebosadero
- Con rebosadero

**Ilustración del producto****Dibujo a escala**

Vaciador automático para lavabo y bidé  
 Acabado: **Cromo** ref.: **94139000**

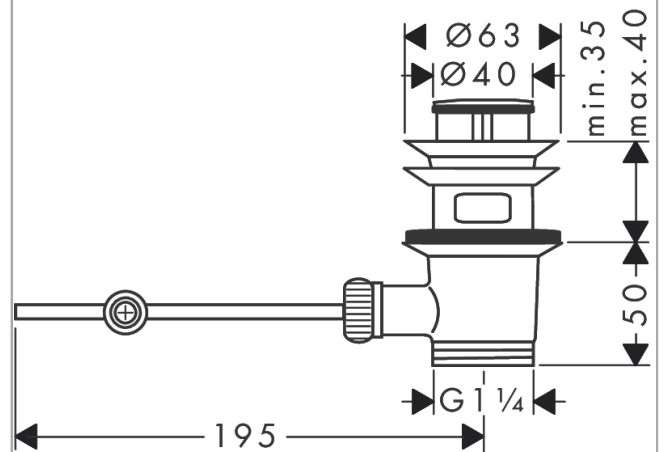

Vista despiezada

Año de fabricación: >05/94

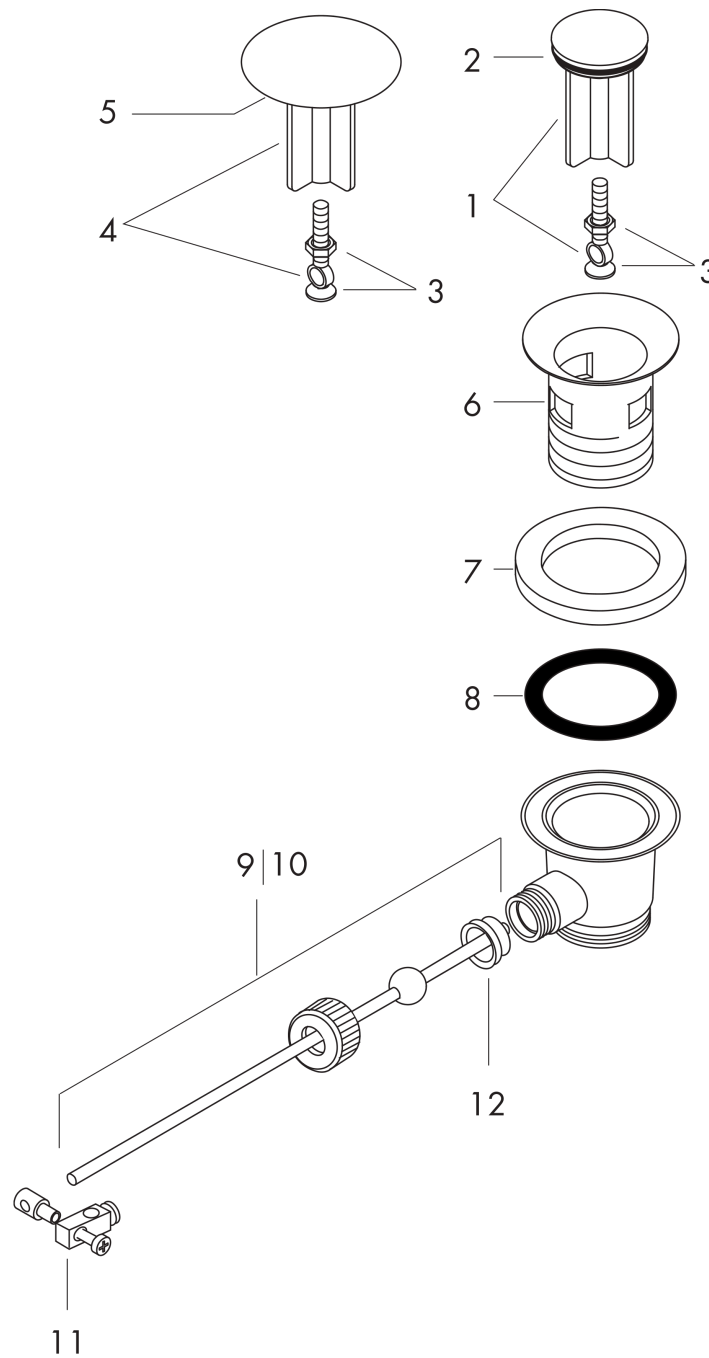



**Vaciador automático para lavabo y bidé**Acabado: **Cromo** ref.: **94139000****Lista de piezas de recambio**Año de fabricación: **>05/94**

<b>Posición</b>	<b>Descripción</b>	<b>ref.</b>	<b>CP</b>	<b>UE</b>
1	Tapón Ø 40 mm	96026000	7	1
2	Junta toroidal 32x3	98051000	1	1
3	Tornillo + tuerca	97522000	2	1
4	Tapón Ø 64 mm	96027000	7	1
5	Junta	97524000	1	1
6	Válvula	96012000	6	1
7	Junta	98506000	3	1
8	Anillo	96361000	3	1
9	Varilla completa 200 mm, bola Ø 12 mm	96007000	5	1
10	Varilla completa 340 mm, bola Ø 12 mm	96324000	7	1
11	Enganche	96100000	2	1
12	Manguito varilla horizontal	96011000	1	1
a	Junta toroidal 35x2,5	96006000	1	1

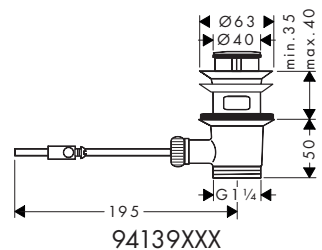
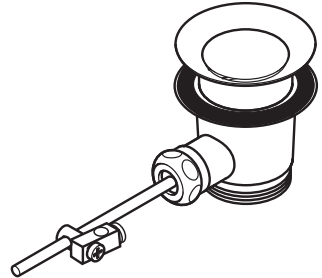
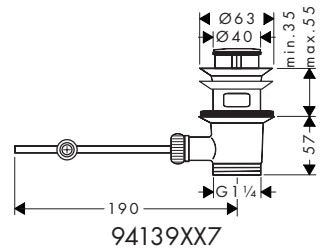
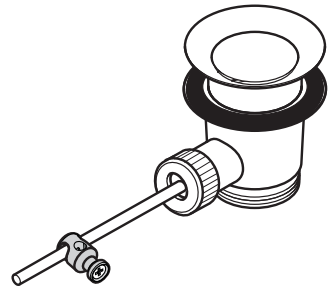
- DE** Montageanleitung
- FR** Instructions de montage
- EN** Assembly instructions
- IT** Istruzioni per Installazione
- ES** Instrucciones de montaje
- NL** Handleiding
- DK** Monteringsvejledning
- PT** Manual de Instalação
- PL** Instrukcja montażu
- CS** Montážní návod
- SK** Montážny návod
- ZH** 组装说明
- RU** Инструкция по монтажу
- FI** Asennusohje
- SV** Monteringsanvisning
- LT** Montavimo instrukcijos
- HR** Uputstva za instalaciju
- RO** Instrucțiuni de montare
- EL** Οδηγία συναρμολόγησης
- SL** Navodila za montažo
- ET** Paigaldusjuhend
- LV** Montāžas instrukcija
- SR** Uputstvo za montažu
- NO** Montasjeveiledning
- BG** Ръководство за монтаж
- JP** 施工説明書
- UA** Інструкція по збірці
- AR** تعليمات التجميع
- TR** Montaj kılavuzu
- HU** Szerelési útmutató
- HE** הוראות הרכבה

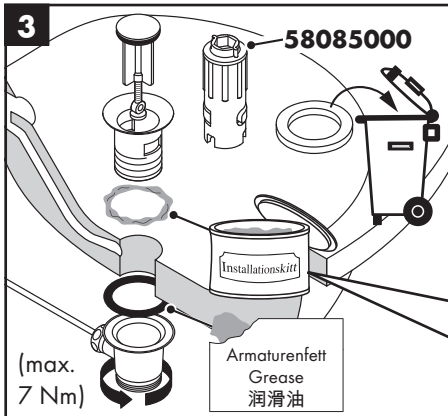
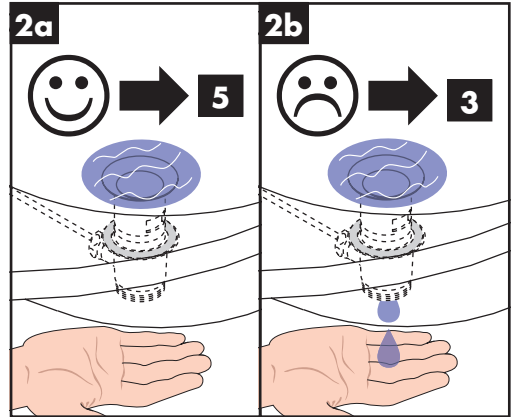
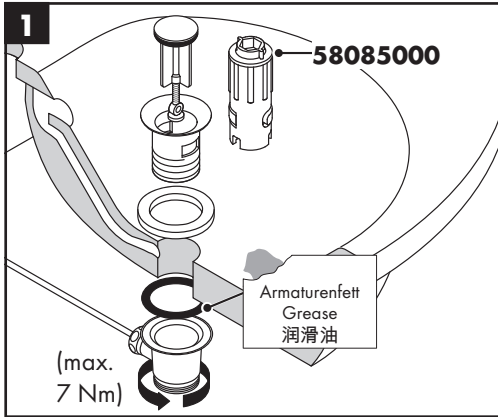



 <p><b>(not included)</b>          Installationskitt          Mastic d'installation          Installation putty          Mastice          d'installazione          Masilla          Kit          Kitt          Mástique</p>	Kit instalatorski Instalačni kit Inštalacná súprava 水管胶泥 Монтаж подводки Aseennussarja Installationskitt Montavimo rinkinys Instalaterski kit Chit de instalare Kit εγκατάσταση Komplet za montažo Paigalduskomplekt Instalācijas piederumi	Instalaterski komplet Installasjonskitt Инсталационен кит 施工用副資材 Шпаклівка монтажна طقم تركيب Montaj silikonu szaniter szilikon מרק להתקנה
--	---	---

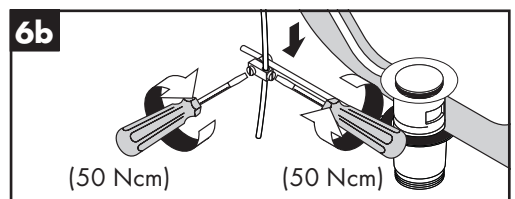
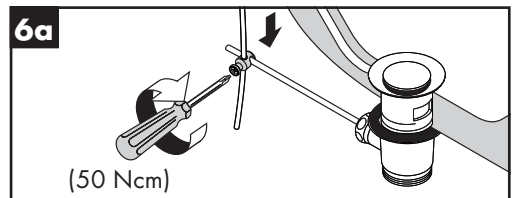
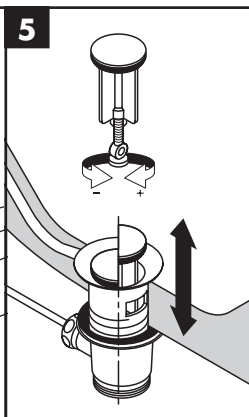
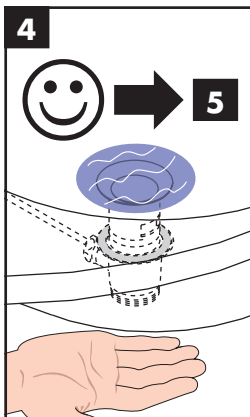

**hansgrohe**